







Soundweb CONTRIO

EC-V		
<p>The Soundweb Contrio EC-V is a wall controller with volume control for use in Harman HiQnet systems. Powered via PoE (Power over Ethernet) and backwardly compatible with existing BSS Audio Soundweb London devices, Crown DCi and other HiQNet devices. Standard EU single gang size. Programmable Push/Rotary encoder and programmable multicolour encoder ring. Sleep function. Available in black or white.</p>		
		
EC-V-BLK-EU	BSS0138	RRP: £260.00
EC-V-WHT-EU	BSS0137	RRP: £260.00

EC-4B		
<p>The Soundweb Contrio EC-V is a wall controller with four assignable buttons for use in Harman HiQnet systems. Powered via PoE (Power over Ethernet) and backwardly compatible with existing BSS Audio Soundweb London devices, Crown DCi and other HiQNet devices. Standard EU single gang size. Four programmable buttons and programmable 64/128 pixel multicolour LCD display. Sleep function. Available in black or white.</p>		
		
EC-4B-BLK-EU	BSS0140	RRP: £340.00
EC-4B-WHT-EU	BSS0139	RRP: £340.00

EC-4BV		
<p>The Soundweb Contrio EC-V is a wall controller with rotary encoder and four assignable buttons for use in Harman HiQnet systems. Powered via PoE (Power over Ethernet) and backwardly compatible with existing BSS Audio Soundweb London devices, Crown DCi and other HiQNet devices. Standard EU single gang size. Four programmable buttons, programmable 64/128 pixel multicolour LCD display, push/rotary encoder and multicolour encoder ring. Sleep function. Remote lock/unlock and local unlock via PIN. Available in black or white.</p>		
		
EC-4BV-BLK-EU	BSS0142	RRP: £390.00
EC-4BV-WHT-EU	BSS0141	RRP: £390.00

EC-8BV		
		
<p>The Soundweb Contrio EC-V is a wall controller with rotary encoder and eight assignable buttons for use in Harman HiQnet systems. Powered via PoE (Power over Ethernet) and backwardly compatible with existing BSS Audio Soundweb London devices, Crown DCi and other HiQNet devices. Standard EU dial gang size. Four programmable buttons, two programmable 64/128 pixel multicolour LCD displays, push/rotary encoder and multicolour encoder ring. Sleep function. Remote lock/unlock and local unlock via PIN. Available in black or white.</p>		
EC-8BV-WHT-EU	BSS0143	RRP: £520.00
EC-8BV-BLK-EU	BSS0144	RRP: £520.00

AC-V		
<p>Analogue Controller with rotary control for use with BSS Audio Soundweb London devices. Requires one GPI on a Soundcraft London device. Available in black or white.</p>		
AC-V-WHT-EU	BSS0145	RRP: £135.00
AC-V-BLK-EU	BSS0146	RRP: £135.00

AC-5S		
<p>Analogue Controller with five-position selector for use with BSS Audio Soundweb London devices. Requires one GPI on a Soundcraft London device. Available in black or white.</p>		
AC-5S-WHT-EU	BSS0147	RRP: £135.00
AC-5S-BLK-EU	BSS0148	RRP: £135.00



Soundweb London

Fixed I/O Devices

BLU-50



The BLU-50 is a half-rack width processor that offers a fixed configuration of four inputs and four outputs, configurable signal processing, logic processing and BLU link. The device can be powered with the included 12VDC power supply but can accept 12-48VDC via a terminal block connector or be powered with PoE+ via the Ethernet port, allowing the device to be powered, configured, controlled and monitored using a single Cat 5e cable.

BLU-50 (UK)	BSS0136	RRP: £1,735.00
-------------	---------	----------------

BLU-100



Networked audio processor. Fixed 12-in, 8 out- configuration. Configurable Signal Processing. Low latency, fault-tolerant 48 channel digital audio bus. Integrates with BLU-800, BLU-320, BLU-160, BLU-120 and BLU-BOB devices. 12 Control Inputs and 6 Logic Outputs allow the BLU-100 to be integrated with GPIO compatible devices. Configuration, control and monitoring from HiQnet London Architect.

BLU-100 (UK)	BSS0118	RRP: £3,190.00
--------------	---------	----------------

BLU-101



Conferencing processor with Acoustic Echo Cancellation. Fixed configuration of 12 analogue inputs and 8 analogue outputs, configurable signal processing, AEC processing, and a high bandwidth, fault tolerant digital audio bus. Compatible with the entire Soundweb London family. Configuration, control and monitoring from HiQnet London Architect.

BLU-101 (UK)	BSS0123	RRP: £4,290.00
--------------	---------	----------------

BLU-102



Conferencing processor with Acoustic Echo Cancellation and Telephone Hybrid card. Fixed configuration of 10 analogue inputs and 8 analogue outputs, an analogue telephone interface, configurable signal processing, AEC processing, and a high bandwidth, fault tolerant digital audio bus. Compatible with the entire Soundweb London family. Configuration, control and monitoring from HiQnet London Architect.

BLU-102 (UK)	BSS0124	RRP: £4,290.00
--------------	---------	----------------

BLU-103



Fixed configuration of 8 analogue inputs and 8 analogue outputs, a Voice over IP (VoIP) interface, configurable signal processing, AEC processing, and a high bandwidth, fault tolerant digital audio bus. The VoIP port enables the BLU-103 to interface with two VoIP (SIP v2.0 or later) lines.

BLU-103	BSS0149	RRP: £4,290.00
---------	---------	----------------

Chassis

BLU-800



Networked audio processor. BLU-Link digital audio bus allows 256 channels of fault-tolerant audio transmission. Configurable DSP with 4x more processing power than the original Soundweb London units. The open architecture is fully configurable through HiQnet™ London Architect and has a rich palette of processing and logic objects and a "drag and drop" method of configuration provide a simple and familiar design environment. CobraNet™ with primary and secondary ports for fault tolerance. 12 Control Inputs and 6 Logic Outputs. Four I/O slots Each slot can accommodate any of six available I/O cards, including the Analog Input Card, Analog Output Card, Digital Input Card, Digital Output Card, AEC Input Card, and Telephone Hybrid Card.

BLU-800	BSS0098	RRP: £6,990.00
---------	---------	----------------

BLU-805



Specifications as per BLU-800 but with the addition of AVB primary and secondary ports instead of CobraNet

BLU-805	BSS0129	RRP: £6,990.00
---------	---------	----------------

BLU-806



Specifications as per BLU-800 but with the addition of Dante primary and secondary ports instead of CobraNet.

BLU-806	BSS0132	RRP: £7,535.00
---------	---------	----------------

BLU-325





Specifications as per BLU-320 but with the addition of AVB primary and secondary ports instead of CobraNet.

BLU-325	BSS0130	RRP: £4,405.00
---------	---------	----------------





BLU-326		
		
Specifications as per BLU-320 but with the addition of Dante primary and secondary ports instead of CobraNet.		
BLU-326	BSS0135	RRP: £4,750.00

BLU-160		
		
Networked audio processor. As per BLU-800 with DSP and BLU-Link digital audio bus but no CobraNet connectivity. Four I/O slots (I/O cards must be specified separately).		
BLU-160	BSS0085	RRP: £4,060.00

BLU-120		
		
Networked audio processor. BLU-Link digital audio bus but no CobraNet connectivity or DSP, allowing it to function as a BLU-Link break in/out unit. Four I/O slots (I/O cards must be specified separately).		
BLU-120	BSS0079	RRP: £2,920.00

Input/Output Cards

BLU-CARD-IN		
Four analogue input card for Soundweb London configurable devices. Four mic/line inputs with software-controlled phantom power and analogue gain, configurable per channel.		
BLUCARD-IN	BSS0048	RRP: £460.00

BLU-CARD-OUT		
Four analogue output card for Soundweb London		
BLUCARD-OUT	BSS0062	RRP: £460.00

BLU-DIG-IN		
Four digital input card for Soundweb London configurable devices. AES-EBU and S/PDIF inputs.		
BLUDIGITAL-IN	BSS0073	RRP: £460.00

BLU-DIG-OUT		
Four digital output card for Soundweb London configurable devices. AES-EBU and S/PDIF outputs.		
BLUDIGITAL-OUT	BSS0074	RRP: £460.00

BLU-AEC-IN		
Four input Acoustic Echo Cancellation input card allows Soundweb London to be used in audio conference applications. Compatible with BLU-800, BLU-320, BLU-160 and BLU-120 devices. Acoustic Gain Control and Noise Cancellation.		
BLUAEC-IN	BSS0116	RRP: £1,520.00

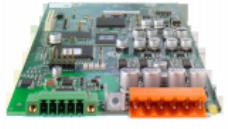
BLU Telephone Hybrid Card		
Four input Acoustic Echo Cancellation input card allows Soundweb London to be used in audio conference applications. Compatible with BLU-800, BLU-320, BLU-160 and BLU-120 devices. Acoustic Gain Control and Noise Cancellation.		
BLUHYBRID	BSS0119	RRP: £760.00

Break-In / Break-Out Boxes

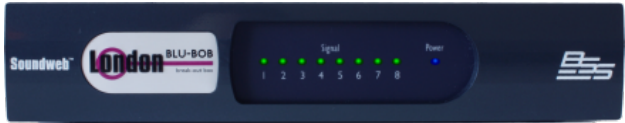
BLU-BOB1		
		
Break-out box. 8 channels of analogue output via the Soundweb London digital audio bus. Configured by 6 DIP switches on the rear of the unit. Available as half (BLU-BOB1) or full (BLU-BOB2) rack width. Requires Soundweb PSU, available separately.		
BLU-BOB1 (UK)	BSS0007	RRP: £960.00

BLU-BOB2		
		
Break-out box. 8 channels of analogue output via the Soundweb London digital audio bus. Configured by 6 DIP switches on the rear of the unit. Available as half (BLU-BOB1) or full (BLU-BOB2) rack width. Requires Soundweb PSU, available separately.		
BLU-BOB2 (UK)	BSS0008	RRP: £1,050.00

BLU-BIB

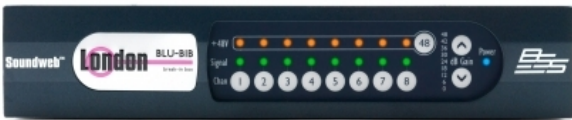

Break-in box/input expander. Provides 8 channels of analogue audio input expansion via the Soundweb London high bandwidth, fault tolerant digital audio bus. 1U, half rack width. DIP Switches for Channel Range Selection. Front panel Input Gain and Phantom Power control. Front Panel lockout for tamper-free operation. 12VDC external power included.

BLU-BIB (UK)	BSS0120	RRP: £1,135.00
--------------	---------	----------------

BLU-USB



USB Audio to BLU link interface. Allows audio from a PC/Mac to be directly placed onto the BLU link audio bus, enabling easy implementation of softphones for conferencing systems or audio playback directly to/from a computer. 2x2 channel @ 48kHz plug-and-play operation (no driver installed), 8x8 channels @ 96kHz with driver installed. Multiple mounting options.

BLU-USB	BSS0154	RRP: £365.00
---------	---------	--------------

BLU-DAN

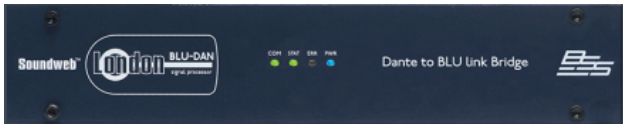

Dante to BLU-link bridge. Configurable through HiQnet Audio Architect, the BLU-DAN is capable of simultaneously transmitting and receiving up to 64 channels of Dante audio (64 x 64). Primary and Secondary ports are provided for fault tolerance. Control is through a separate Ethernet port.

BLU-DAN	BSS0150	RRP: £1,370.00
---------	---------	----------------

Controllers

BLU-3



Rotary fader and a five-way switch. The switch could select system presets while the rotary control could be assigned to act as a zone volume control.

BLU-3	BSS0038	RRP: £225.00
-------	---------	--------------

BLU-6



Eight-way spin pair controller. Eight-way switch plus a pair of spin or up/down buttons, enabling the same level parameter to be mapped onto other controllers preventing a jump in audio level when the control is adjusted.

BLU-6	BSS0032	RRP: £255.00
-------	---------	--------------

BLU-8 v2



HiQnet compatible programmable zone controller capable of controlling a single zone, four zones or eight zones in different modes of operation. A simple control surface and informative visual feedback ensure that non-technical users can be confident in making changes to an integrated AV system. Available in black or white

BLU-8-V2-BLK	BSS0127	RRP: £915.00
BLU-8-V2-WHT	BSS0126	RRP: £915.00

Accessories

BLU-GPX

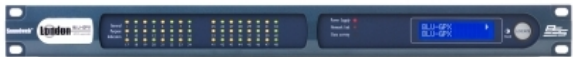

Network-controlled GPIO expander. 36 Control Inputs, 23 Control Outputs, 8 integrated Relay Outputs and 47 Common (ground) connections, 12 Reference Connections for 3-wire mode, 1 Opto-Isolator for fault monitoring, 2 PoE-Enabled ethernet ports for configuration, control, monitoring, primary power, and redundant comms.

BLU-GPX	BSS0133	RRP: £2,430.00
---------	---------	----------------

BLU-SI



The BSS BLU-SI card is a 32 x 32 interface between Soundcraft Si Series consoles and the BLU Link digital audio bus. The card allows connection to a wide variety of Harman products equipped with a BLU Link interface such as BSS London BLU 800, dbx@ PMC or Crown@ PIP-BLU interfaces amongst others.

BLU-SI	BSS0134	RRP: £835.00
--------	---------	--------------

BLU-RACK



19" rack mounting kit for up to two BLU-BIB or BLU-BOB1 devices.

RACK MOUNT KIT	BSS0125	RRP: £130.00
----------------	---------	--------------



BLU-HIF

Telephone Headset Interface. Allows connection between the headset jack of a VoIP/digital phone to an AEC input and analogue output of a Soundweb London device. Features RJ-22 jack, balanced input and balanced outputs.



BLU-HIF	BSS0121	RRP: £385.00
---------	---------	--------------

DI Box

AR133CH



The industry standard DI box. Phantom power and battery supplies as standard. Rugged aluminium extrusion case with robust polyurethane end-cheeks. 1/4" jack and XLR input connections. Input attenuation (-20 & -40dB) making the box suitable for instrument, line or amplifier levels on inputs. Ground-lift switch is provided for a solution to ground-loop problems.

AR-133	BSS0106	RRP: £205.00
--------	---------	--------------